

aplicaciones eléctricas



Nuestra experiencia avala las mejores soluciones...



*Especialistas en materiales avanzados para
utilización en aplicaciones eléctricas.*



Carbones y Sistemas, S.L.L.

C/ Av. Los Pocillos, 10

Nave 1 - P.I. La Carrehuela
28340 Valdemoro (Madrid)

Tel.: +34 91 895 38 80

Fax: +34 91 809 23 46

mail@carbosystem.com

www.carbosystem.com

aplicaciones eléctricas



escobillas

Los productos de **Carbosystem** para aplicaciones eléctricas, están basados en materias primas de primera calidad de los principales fabricantes de grafito. Dentro de nuestra gama de productos, podemos destacar a las *ESCOBILLAS*, *PORTAESCOBILLAS* Y *FROTADORES*, como los más importantes dentro de las aplicaciones en el sector eléctrico.

ESCOBILLAS

Carbosystem dispone de las calidades necesarias para dar respuesta a cualquier tipo de aplicación.

Es importante, en cualquier caso, conocer datos sobre el tipo de motor y las condiciones de trabajo (carga, influencias atmosféricas o químicas, vibraciones, etc.).



APLICACIONES:

- Motores de c.c. alta potencia
- Motores de c.a.
- Anillos rozantes
- Dinamos tacométricas
- Micromotores
- Turboalternadores
- Motores de tracción
- Motores para carretillas elevadoras

CALIDADES:

- Carbográficas
- Baquelíticas
- Metalográficas
- Electrográficas



Carbones y Sistemas, S.L.L.

C/ Av. Los Pocillos, 10

Nave 1 - P.I. La Carrehuela
28340 Valdemoro (Madrid)

Tel.: +34 91 895 38 80
Fax: +34 91 809 23 46

mail@carbosystem.com
www.carbosystem.com

aplicaciones eléctricas



escobillas

CALIDADES

■ CARBOGRAFITICAS

Adecuadas para bajas o moderadas velocidades y moderadas densidades de corriente, Recomendadas para motores de potencia fraccionada.

■ BAQUELITAS

Se usan en diversas aplicaciones como turboalternadores de gran velocidad, anillos de deslizamiento, carretillas a baterías o motores de corriente alterna con colector

■ METALOGRAFICAS

Se componen de grafito con polvo de metal en proporciones desde el 4% hasta el 98%. Básicamente los metales utilizados son el cobre y aleaciones de diferentes metales. Aconsejadas para generadores con bajo voltaje y alta densidad de corriente.

■ ELECTROGRAFITICAS

Cubren un amplio espectro de aplicaciones en los motores de corriente continua. Especiales para equipos con altas velocidades, alta densidad de corriente y alto voltaje. Pueden ir con diferentes tipos de impregnación.

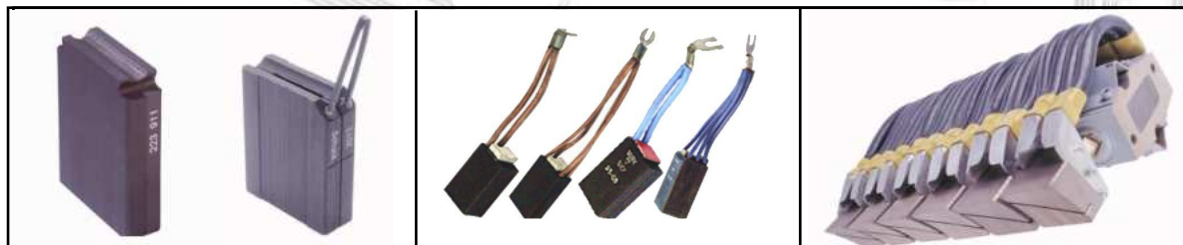

DIMENSIONES

Las dimensiones de las escobillas se miden de la siguiente forma:

t x a x r

t = tangencial

En dirección a la circunferencia

a = axial

En dirección al eje.

r = radial

En dirección al diámetro.

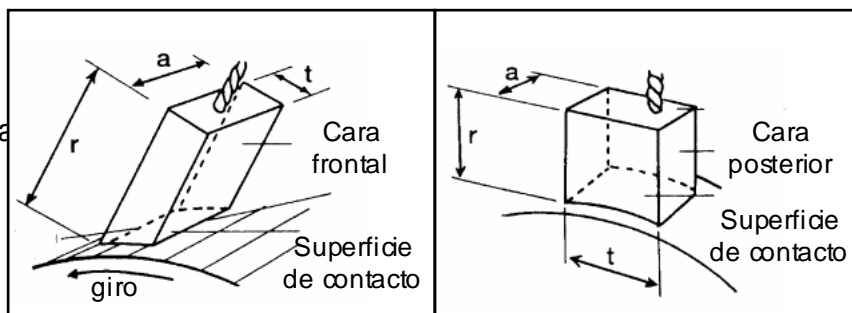

Carbones y Sistemas, S.L.L.

C/ Av. Los Pocillos, 10

Nave 1 - P.I. La Carrehuela
28340 Valdemoro (Madrid)

Tel.: +34 91 895 38 80
Fax: +34 91 809 23 46

mail@carbosystem.com
www.carbosystem.com

aplicaciones eléctricas



portaescobillas

PORTAESCOBILLAS

Carbosystem suministra portas para máquinas AC/DC, Turboaltemadores, tracción, etc. Así mismo, otro tipo de sujeciones como abrazaderas con muelle y resortes son ofrecidos.

Podemos fabricar cualquier tipo de porta, bajo diseño o muestra del cliente.



FROTADORES

Los frotadores se pueden utilizar para la transmisión de corriente en pantógrafos y puentes grúa.

Normalmente es empleada una calidad grafito + metal para facilitar el paso de la corriente y al mismo tiempo como lubricación en los carriles de deslizamiento.

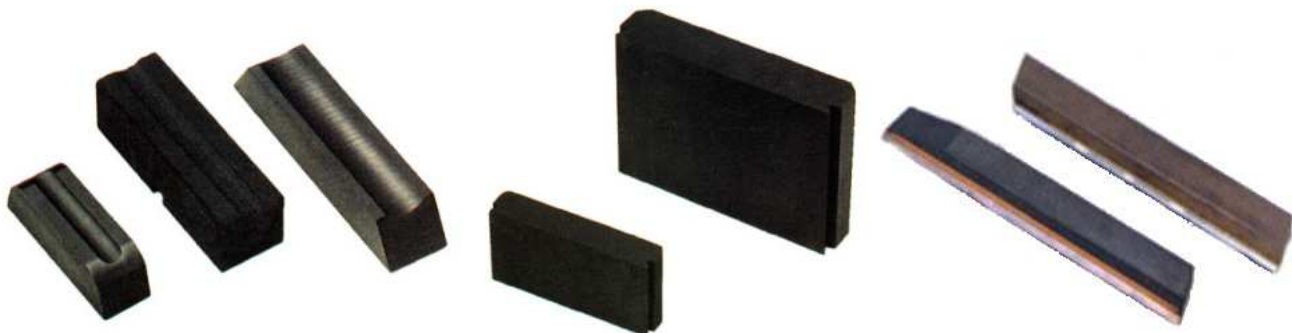

Carbones y Sistemas, S.L.L.

C/ Av. Los Pocillos, 10
Nave 1 - P.I. La Carrehuela
28340 Valdemoro (Madrid)

Tel.: +34 91 895 38 80
Fax: +34 91 809 23 46

mail@carbosystem.com
www.carbosystem.com

aplicaciones eléctricas



portaescobillas



08CE016025A
16 x 25



08CD010012A
10 x 12



08TA032042A
32 x 42



08TB020032A
20 x 32



08X006008A
6 x 8



08X012025A
12 x 25



08CA016032A
16 x 32



08CGB025050A
25 x 50



08TAD038038A
38 x 38



08TC025032A
25 x 32



08L025032A
25 x 32



08TAB020032A
20 x 32



08CF020050A
20 x 50



08TAB012050A
12 x 50



08CC016032A
16 x 32



08CF020064A
20 x 64



08XMB010032A
10 x 32



08Y1B010025E
10 x 25



08Y2B020040E
20 x 40



08L025032E
25 x 32



Carbones y Sistemas, S.L.L.

C/ Av. Los Pocillos, 10

Nave 1 - P.I. La Carrehuela
28340 Valdemoro (Madrid)

Tel.: +34 91 895 38 80

Fax: +34 91 809 23 46

mail@carbosystem.com

www.carbosystem.com

aplicaciones eléctricas



portaescobillas



08XD010016C
10 x 16



08TC025032E
25 x 32



08JD020040A
20 x 40



08JD016040C
16 x 40



08V4Z10006012B2A
6 x 12

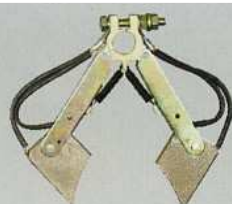

08VH12006026D3A
6 x 26

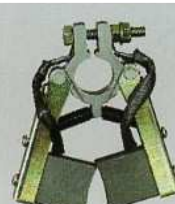

08VL16008022D1
8 x 22



08V12006012A
6 x 12



08NA012020
12 x 20

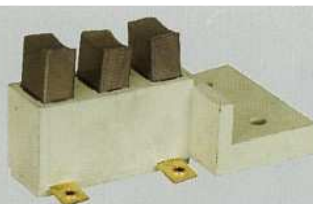

08F006014H3
6 x 14

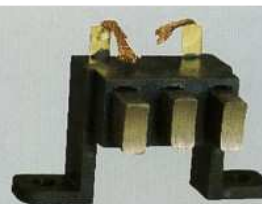

08FA007015H3
7 x 15

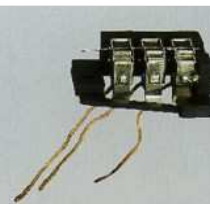

08FB010016H2
10 x 16



08FS003006K3
3 x 6 / 7 x 12



08FB005007K3
5 x 7



08WST008025H4
8 x 25



08FB005007H2
5 x 7

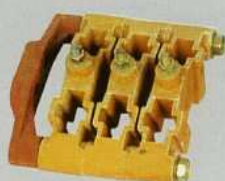

08HY010025I
10 x 25



08YS010025I
10 x 25

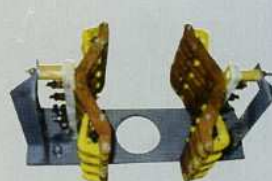

08YS016040I
16 x 40



08E008013A
8 x 13



Carbones y Sistemas, S.L.L.

C/ Av. Los Pocillos, 10

Nave 1 - P.I. La Carrehuela
28340 Valdemoro (Madrid)

Tel.: +34 91 895 38 80

Fax: +34 91 809 23 46

mail@carbosystem.com

www.carbosystem.com

aplicaciones eléctricas



portaescobillas



12,5 x 25
MD5001101



16 x 25
MD5001102



32 x 42
MD5001103



2 x 16 x 32
MD5001104



25 x 32
MD5001105



20 x 32
MD5001106



10 x 25
MD5001107



20 x 32
MD5001108



2 x 12,5 x 32
MD5001109



2 x 16 x 32
MD5001110



25 x 32
MD5001111



10 x 25
MD5001112



10 x 13
MD5001113



16 x 80
MD5001114



12,5 x 32
MD5001115



16 x 32
MD5001116



16 x 25
MD5001117



12 x 25
MD5001118



20 x 25
MD5001119



25 x 32
MD5001120



Carbones y Sistemas, S.L.L.

C/ Av. Los Pocillos, 10
Nave 1 - P.I. La Carrehuela
28340 Valdemoro (Madrid)

Tel.: +34 91 895 38 80 mail@carbosystem.com
Fax: +34 91 809 23 46 www.carbosystem.com

aplicaciones eléctricas



portaescobillas



16 x 32
MD5001121



25 x 30
MD5001122



20 x 30
MD5001123



20 x 32
MD5001124



25 x 32
MD5001125



25 x 32
MD5001126



30 x 30
MD5001127



12,5 x 50
MD5001128



16 x 32
MD5001129



25 x 50
MD5001130



25 x 32
MD5001131



16 x 32
MD5001132



16 x 32
MD5001133



16 x 32
MD5001134



4 x 38 x 38
MD5001135



12,5 x 30
MD5001136



16 x 25
MD5001137



12,5 x 25
MD5001139



2 x 12,5 x 32
MD5001138



2 x 10 x 12,5
MD5001140



Carbones y Sistemas, S.L.L.

C/ Av. Los Pocillos, 10
Nave 1 - P.I. La Carrehuela
28340 Valdemoro (Madrid)

Tel.: +34 91 895 38 80 mail@carbosystem.com
Fax: +34 91 809 23 46 www.carbosystem.com